

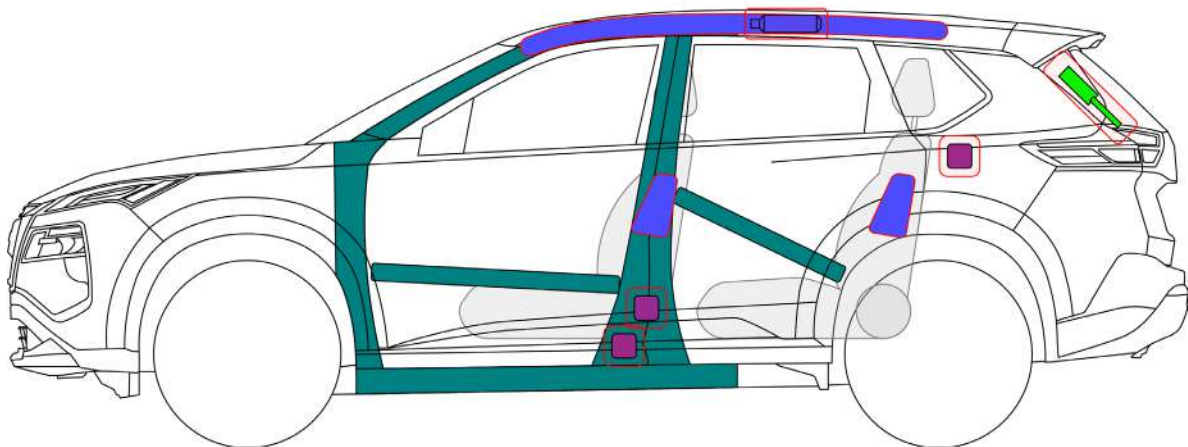

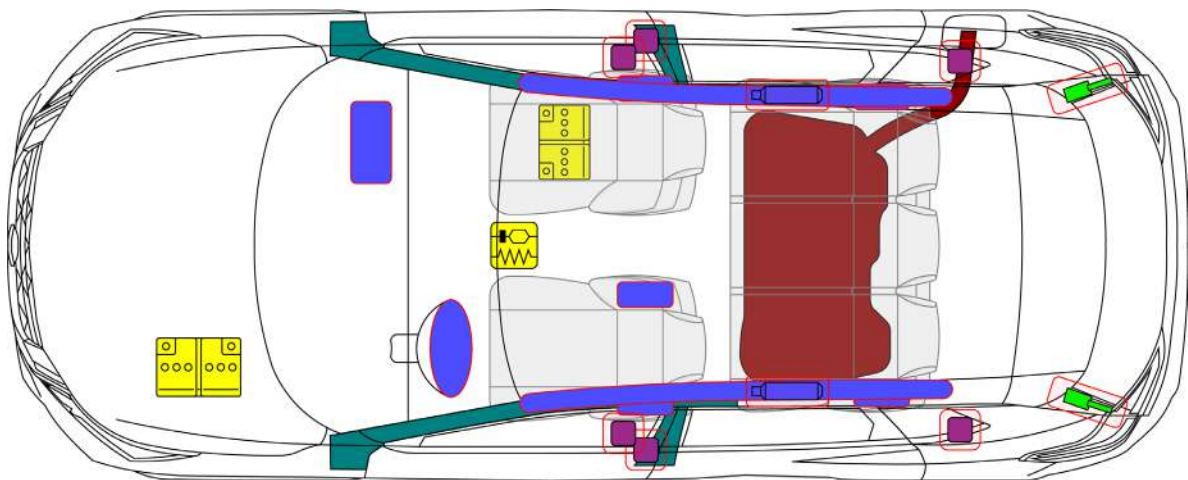







Nissan X-Trail

TYPE: T33, 5-door SUV
(2022 -)



 Zračni jastuk	 Plinski generator	 Zatezač sigurnosnog pojasa	 SRS upravljački uređaj	 Niskonaponski akumulator
 Plinsko-hidraulični podupirač / zategnuta opruga	 Područje visoke otpornosti	 Spremnik za benzin/etanol		

1. Identifikacija



2. Imobilizacija / stabilizacija / dizanje

Imobilizirajte vozilo:

1. Zaključajte kotače
2. Zategnite ručnu kočnicu
3. Pritisnite gumb P (parkiranje) za odabir položaja P (parkiranje)

Točke podizanja:

 Odgovarajuće točke za podizanje

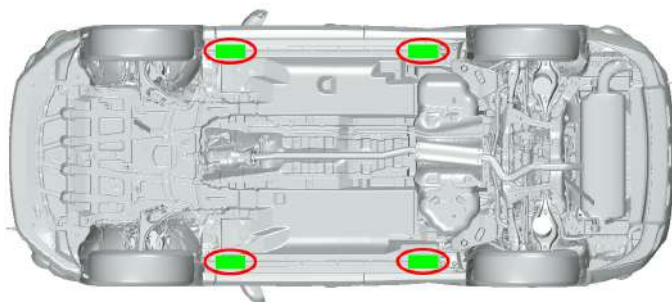

3. Sigurnosni propisi / izključivanje opasnosti

1. Pritisnite tipku Start/Stop za isključivanje motora



Zatim uklonite elektronički ključ i držite ga najmanje 16 ft (5 m) dalje od vozila

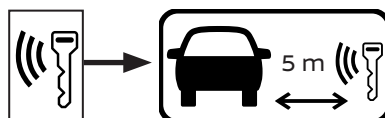

Pristup motornom prostoru



2. Odvojite 12-voltni akumulator

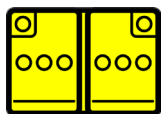

4. Pristup putnicima

Čelik visoke čvrstoće u kućištu i vratima



Podešavanje stupa upravljača



Podešavanje sjedala

Električni



Ručno



Vrste stakla:

- A. Laminirano staklo
- B. Kaljeno staklo



5. Spremljena energija / tekucine / plinovi / kruta goriva

	12V	
	R-1234yf 1005 g	
	55L	
	12V Li-ion	

8. Transport / skladištenje / odvuci

Skladištenje ušice za vuču



Mjesto prednja kuka



Mjesto stražnje kuke



Vuča

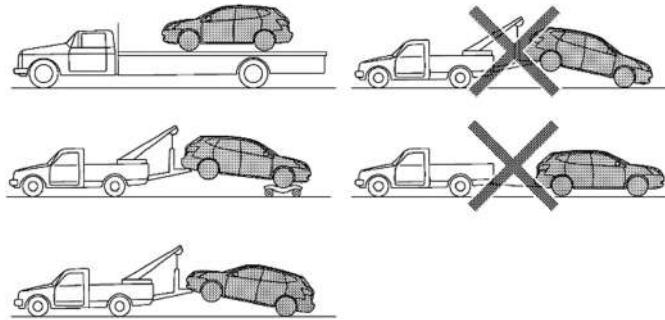

10. Objasnjenje piktograma

	Uklanjanje pametnog ključa		Zapaljivo
	Opći znak upozorenja		Opasno za ljudsko zdravlje
	Upozorenje, niska temperatura		Eksplziv
	Komponenta klima-uređaja		Korozivna tvar
	Vozilo na gorivo skupine tekućina 1		Poklopac motora